

2-port valve & actuator MVI421../2

3-port valve & actuator MXI421../2



2-Port and 3-Port Zone Valves & Actuators, PN16



MVI421../2
MXI421../2

- Operating voltage AC 230 V, 2-position control signal
- Spring return
- Positioning force 200 N
- Direct mounting with union nut, no tools required
- Ergonomically designed manual adjuster
- Auxiliary switch, type ASC2.1/18 (optional)
- Hot-pressed brass valve body
- DN 15, DN 20 and DN 25
- k_{vs} 2...5 m³/h
- Internally threaded connections Rp.. to ISO 7-1

Use

- In ventilation and air conditioning systems for water-side terminal unit control in closed circuits, e.g. induction units, fan coil units, small re-heaters and small re-coolers, for use in
 - 2-pipe systems with 1 heat exchanger for heating and cooling
 - 4-pipe systems with 2 separate heat exchangers for heating and cooling
- In closed-circuit zone heating systems, e.g.
 - Separate floors in a building
 - Apartments
 - Individual rooms
 - Floor heating

Type summary

Type	Stock number	DN	Connections	PN class	k_{vs}  A→AB [m ³ /h]	
MVI421.15/2	S55310-M100	15	Rp ½"	16	2.15	
MVI421.20/2	S55310-M101	20	Rp ¾"		3.5	
MVI421.25/2	S55310-M102	25	Rp 1"		5.0	
Type	Stock number	DN	Connections	PN class	k_{vs}  AB→A [m ³ /h]	k_{vs}  AB→B [m ³ /h]
MXI421.15/2	S55310-M103	15	Rp ½"	16	2.15	1.5
MXI421.20/2	S55310-M104	20	Rp ¾"		3.5	2.5
MXI421.25/2	S55310-M105	25	Rp 1"		5.0	3.5

		Valves		Actuator	
2-port	3-port	Δp_s [kPa]	Δp_{max} [kPa]	Positioning force	Control signal
MVI421.15/2	MXI421.15/2	300	300 ¹⁾	200 N	2-position
MVI421.20/2	MXI421.20/2	300	300 ¹⁾		
MVI421.25/2	MXI421.25/2	250	250 ¹⁾		

¹⁾ Where Δp_{max} is above 100 kPa, there is an increased risk of noise and erosion on the seat and plug

k_{vs} = Nominal flow rate of cold water (5 to 30 °C) through the fully open valve (H_{100}), by a differential pressure of 100 kPa (1 bar)

Δp_s = Maximum permissible differential pressure at which the motorized valve will close securely against the pressure (close off pressure)

Δp_{max} = Maximum permissible differential pressure across the valve's control path, valid for the entire actuating range of the motorized valve

Accessories

Type	Designation	Switching point	Contact rating
ASC2.1/18	Auxiliary switch on / off	At approx. 50 % stroke	Max. AC 250 V, 3 (2) A

Equipment combinations

Thermostats

Type	Thermostats compatible to MVI421../2 / MXI421../2
RAA...	RAA11; RAA21; RAA31; RAA41; RAA20LD-GB
RAB...	RAB11...; RAB21; RAB31...
RCC...	RCC10; RCC20; RCC30
RCU...	RCU10
RDF...	RDF110...; RDF300...; RDF310...; RDF510...; RDF530...; RDF600...; RDF800...
RDG...	RDG100...; RDG110; RDG160...
RDH...	RDH100...
RDJ...	RDJ100...
RDD...	RDD100...; RDD310....
RDE...	RDE100...; RDE410...
REV...	REV13...; REV24...
RDS...	RDS110

Ordering

When ordering, please specify the quantity, product name and number.

Example

Product name	Stock number	Quantity
MVI421.20/2	S55310-M101	10

Delivery

The valves and actuators are packed together; the auxiliary switches will be packed separate.

Technical and mechanical design

The zone valves are closed when de-energised. An on/off controller (thermostat) is required to drive the motorised valve actuators. If the temperature of the medium deviates from the set point, the controller delivers a control signal that drives the actuators, causing the valve to open. When the temperature of the medium reaches the set point the control signal is cut off and the valve closes.

The valve is opened electrically by the actuator and closed by spring force. The actuator incorporates a synchronous motor, a gear mechanism and a return spring. The electric motor is overload-resistant and anti-locking, so that continuous operation is possible. The maximum stroke is limited mechanically. The closing motion, by contrast, includes an overrun for the gear mechanism. This protects the gear mechanism from mechanical shock and increases service life.

Accessories

ASC2.1/18 auxiliary switch

The optional auxiliary switch can be fitted to the actuator with two screws.
It switches at a stroke of approx. 50 %.

0...50 % : Q11 → Q12 closed Q11 → Q14 open
50 %...1 : Q11 → Q12 open Q11 → Q14 closed

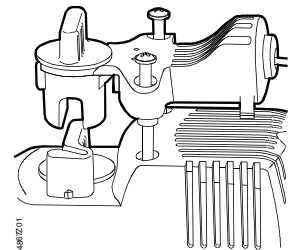

See «Technical data» for further information on the auxiliary switch.

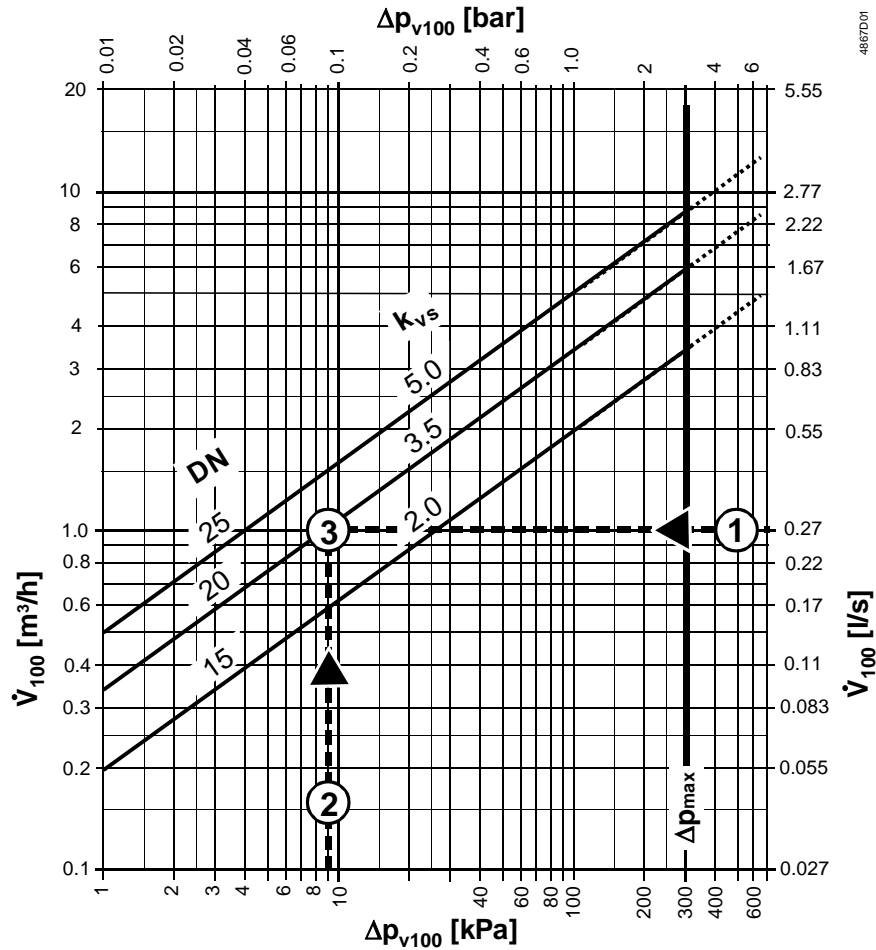

Δp_{v100} = Differential pressure across the fully opened valve and the valve's control path A → AB (2-port valves), AB → A (3-port diverting valves) by a volume flow \dot{V}_{100}
 \dot{V}_{100} = Volume flow through the fully open valve (H_{100})
 Δp_{max} = Maximum permissible differential pressure across the valve's control path, valid for the entire actuating range of the motorised valve
 100 kPa = 1 bar ≈ 10 mWC
 1 m³/h = 0.278 l/s water at 20 °C

Example:

- 1 \dot{V}_{100} = 0.27 l/s
- 2 Δp_{v100} = 9 kPa
- 3 K_{vs} value required = 3.5 m³/h

Engineering notes

The admissible temperatures (see «Technical data») must be observed.



Electrical installation



- The actuator may be operated only with alternating current AC 230 V.
- For safety and protection reasons connect the actuator with a suitable cable conduit, e.g. 
- **Phase cut and pulse-duration-modulated signals are not suitable.**
- Recommended number of opening/closing operations: approx. 50 per day, with 200 heating or cooling days

The valves should preferably be installed in the return, where the seals are exposed to lower temperatures. It is not allowed to put a shut off at the bypass port B.

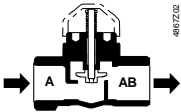
Recommendation A strainer should be fitted upstream of the valve. This increases reliability.

Valve construction	Valve series	Valve flow in control mode		Valve stem	
		Inlet A	Outlet AB	Retracted	Extended
2-port valves 	MVI421../2 	Variable	Variable	A → AB closes	A → AB opens

Warning The direction of flow **MUST** be as indicated by the arrow, from A → AB.

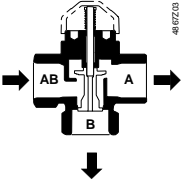
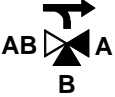
Valve construction	Valve series	Valve flow in control mode			Valve stem	
		AB	A	B	Retracted	Extended
3-port diverting valves 	MXI421../2 	Inlet: constant	Outlet: variable	Outlet: variable	AB → A closes AB → B opens	AB → A opens AB → B closes

Warning The direction of flow **MUST** be as indicated by the arrow, from AB → A and AB → B (diverting valves).

Mounting notes

Mounting instructions A6V11250782 are enclosed with the packaging

Orientation

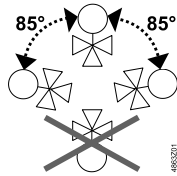

Mounting

The direction of flow as described under «Engineering notes» must be observed. Assembly is made with the coupling nut; no adjustments are required.

The actuator must be fitted in position 1 (also refer to «Manual operation»):

- Position the actuator and tighten the coupling nut manually
- Do not use any tools such as wrenches
- The actuator must not be lagged

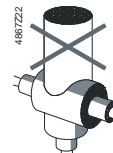

Caution

Suitable conduit shall connect to the actuator when undergone the wiring work of the product.

Commissioning notes

- The valve may be commissioned only with the manual wheel pre-set or with a correctly mounted actuator.
- Check the wiring.
- Check the functioning of the actuator and of the auxiliary switch, if fitted.

Manual adjustment

The valve can be opened manually by use of a lever on the actuator. When the valve is approximately 90% open the lever locks into position. When electrical operation is

resumed, the locking mechanism is released automatically. The valves will be opened by their own spring (normally open).

Open valve manually

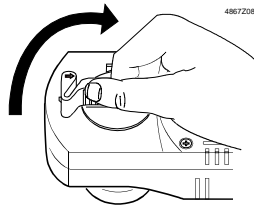

Rotate lever

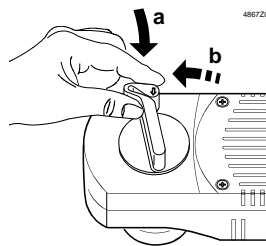

The lever is locked into position at a valve opening of approx. 90 %

Release lever manually

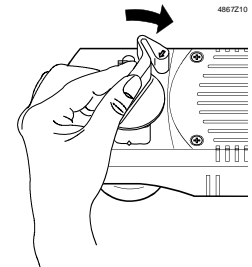

Rotate lever as far as the mechanical stop and release.

Maintenance notes

The valve and actuator require no maintenance.

Warning

Before performing any service work on the valve or actuator:

- Switch off the pump and power supply
- Close the main shut-off valves in the pipework
- Release pressure in the pipes and allow them to cool down completely

If necessary, disconnect electrical connections from terminals.

The actuator cannot be repaired. Faulty actuators can be replaced without removing the valve from the pipe work.

Replacement actuator

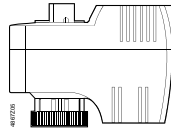

Replacement actuators can be ordered by quoting type code: SFA21

Disposal



The valve must be dismantled and separated into its various constituent materials before disposal.

The actuator may not be disposed of together with domestic waste.

Legislation may demand special handling of certain components, or it may be sensible from an ecological point of view.

Current local legislation must be observed.

Warranty

The technical data supplied for these valves is valid only for valves used in conjunction with the actuators SFA...

Use with third-party actuators invalidates any warranty offered by Siemens Switzerland Ltd / HVAC Products.

Technical data

Valves		
Operating data	PN class	PN 16 to EN 12266-1
	Permissible operating pressure	1600 kPa (16 bar)
	Valve characteristic	The valves are designed for ON/OFF control only.
	Leakage	According to DIN EN 1349
	2-port valve: Path A → AB	0...0.05 % of k_{vs}
	3-port valve Path AB → A	0...0.05 % of k_{vs}
	Bypass AB → B	Max. 2...5 % of k_{vs}
	Permissible media	Chilled water, low-temperature hot water and water with antifreeze. Recommendation: water should be treated as specified in VDI 2035
Temperature of medium	1...110 °C	
Nominal stroke	2.5 mm	
Standards	Environmental compatibility	ISO 14001 (Environment) ISO 9001 (Quality) 2011/65/EC (RoHS)
	Valve body	Hot-pressed brass
	Stem	Stainless steel
Materials	Plug, seat, gland	Brass
	Sealing glands	EPDM O-rings
	Dimensions and weight	Refer to «Dimensions»
Dimensions / Weight	Threaded connections (valve)	Rp to ISO 7-1 (internally threaded)

Actuators		
Power supply	Operating voltage	AC 230 V
	Voltage tolerance	-15/+10 %
	Frequency	50/60 Hz
Control	Power consumption	12 VA
	Primary fuse	External (max 3 A)
	Positioning signal	2-position ¹⁾
	Parallel operation of several actuators	Permitted ²⁾
Operating data	Opening / closing operations	Recommended number: approx. 10'000 / year (equivalent to approx. 50 per day)
	Position with de-energized actuator	
	2-port valve (MVI421../2)	A → AB closed
	3-port valve (MXI421../2)	AB → A closed
	Positioning time (open / close)	50 Hz: 10 s 60 Hz: 8 s
	Nominal stroke	2.5 mm
	Positioning force	200 N
	Manual adjustment	0...90 %
Standards	Housing protection	IP30 to EN 60529 ³⁾
	Upright to 85 ° horizontal, do not suspend	
	Environmental compatibility	ISO 14001 (Environment) ISO 9001 (Quality) SN 36350 (Environmentally compatible products) RL 2002/95/EG (RoHS)
Mounting	Fixing on valve	Plastic union nut M30 x 1.5

Actuators		
Dimensions / Weight	Dimensions and weight	see «Dimensions»
	Weight	without auxiliary switch: 0.585 kg with auxiliary switch: 0.692 kg
Materials	Base-plate	die-cast aluminum
	Housing	PBT
	Union nut	Brass, nickel plated mat
Housing colors	Base and cover	Light gray, RAL7035
	Lever	Pigeon blue, RAL5014
Auxiliary switch ASC2.1/18	Switch type	Changeover contact
	Switching point	At approx. 50 % stroke
	Switching capacity	AC 250 V (3 A resistive, 2 A inductive)
	Connecting cable	3-core, 1.8 m / AWG18 (0.96 mm ²)

- 1) Phase cut and pulse-duration-modulated (PDM) signals are not suitable.
- 2) Consider controller's output power
- 3) Standard is only met when the actuator is connected with a suitable cable conduit.

General ambient conditions	Operation	Transport	Storage
	EN 60721-3-3	EN 60721-3-2	EN 60721-3-2
Environmental conditions	Class 3K3	Class 2K3	Class 2K3
Temperature	1...50 °C	-25...70 °C	-5...50 °C
Humidity	5...85 % r. h.	< 95 % r. h.	5...95 % r. h.

Connecting cable and terminals

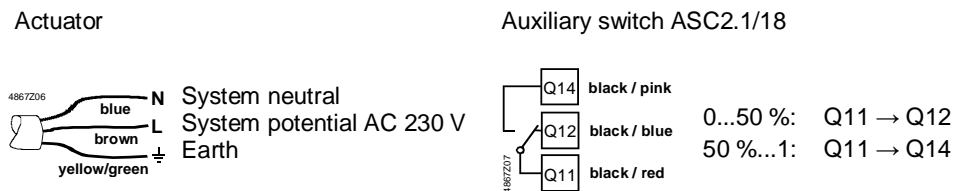

Connection diagram

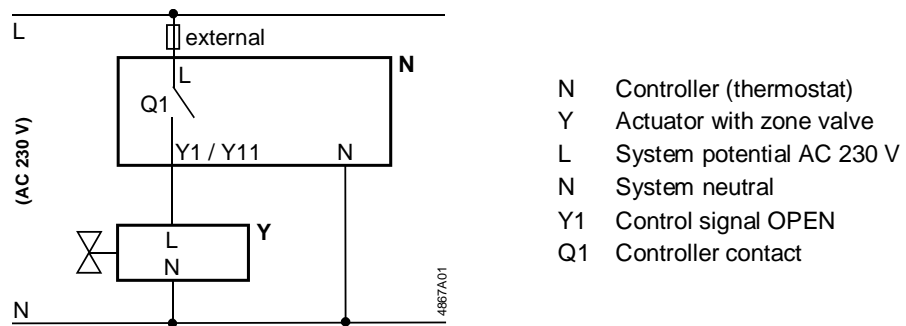

Dimensions

All dimensions in mm

2-port valves

MVI421.../2

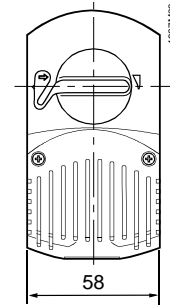
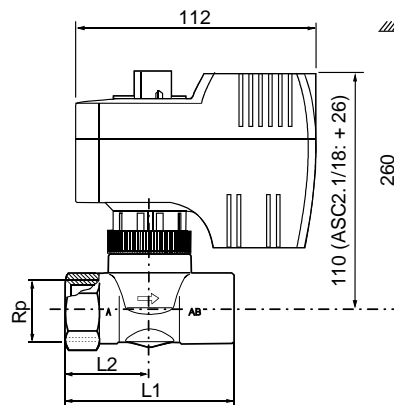

Type	DN	Rp [inches]	L1 [mm]	L2 [mm]	$\frac{m}{kg}$ [kg]
MVI421.15/2	15	Rp $\frac{1}{2}$	60	30	0.796
MVI421.20/2	20	Rp $\frac{3}{4}$	65	32.5	0.837
MVI421.25/2	25	Rp1	84	45	1.077

3-port valves

MXI421.../2

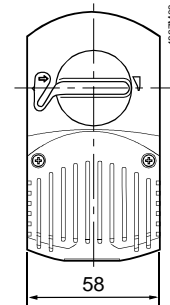
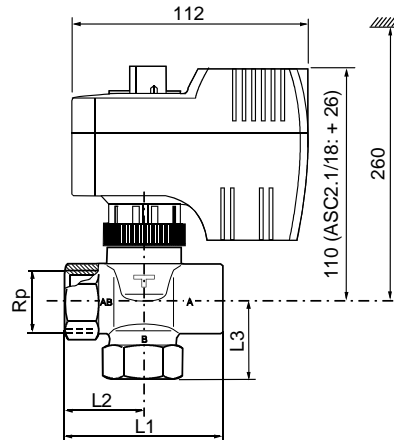

Type	DN	Rp [inches]	L1 [mm]	L2 [mm]	L3 [mm]	$\frac{m}{kg}$ [kg]
MXI421.15/2	15	Rp $\frac{1}{2}$	60	30	30	0.844
MXI421.20/2	20	Rp $\frac{3}{4}$	65	32.5	32.5	0.892
MXI421.25/2	25	Rp1	84	45	40	1.168